

版本 REV.	日期 DATE	ECN NO.	变更内容 DESCRIPTION	制图 DRAWN

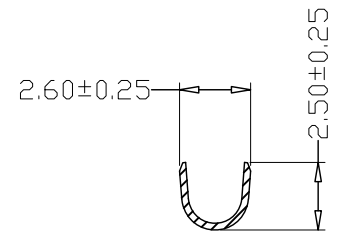

SEC: A-A

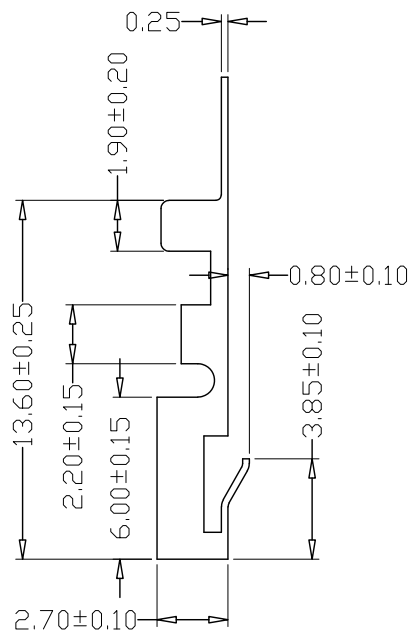
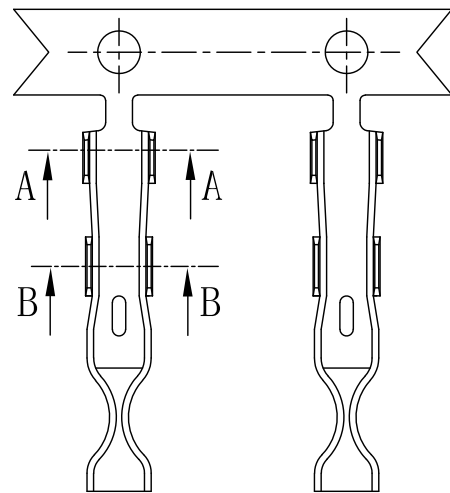
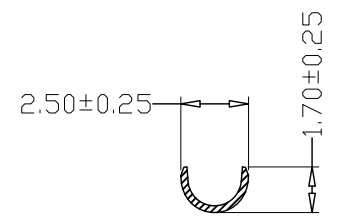

SEC: B-B

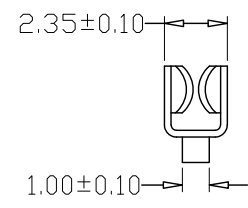

SPECIFICATIONS

- 1、Current Rating: 7A AC, DC
- 2、Voltage Rating: 250V AC, DC
- 3、Temperatuer Range: -25°C~+85°C
- 4、Contact Resistance: 20mΩ Max
- 5、Insulation Resistance: 1000MΩ Min
- 6、Withstanding Voltang: 1500V AC/minute
- 7、Material: Phosphoric bronze Tin-plated
- 8、Applicable Wire Sizes: AWG#18~22#

GENERAL TOLERANCE		制图 Mapping	张迎春 2022、09、19	料号 PART NO.	A750-501-02-T	版本 REV.	A
X.±0.25	X.°±2°	审核 Audit	钱岳生 2022、09、19	品名 TITLE	CJ84端子	页次 SHEET	1/1
.XX±0.25	.X°±1°	核准 Approved	张名 2022、09、20	客户料号 CUTM. NO.			
.XXX±0.15	.XX°±0.5°	单位 Units	mm	比例 SCALE			
.XXX±0.10	.XXX°±0.5°			乐清市宏一电子有限公司 YueQing HongYi Electronics Co., Ltd			

版本 REV.	日期 DATE	ECN NO.	变更内容 DESCRIPTION	制图 DRAWN

PIN	尺寸 (mm)		
	A	B	C
-02Y	7.50	15.20	12.85
-03Y	12.50	20.20	17.85
-04Y	17.50	25.20	22.85
-05Y	22.50	30.20	27.85
-06Y	27.50	35.20	32.85
-07Y	32.50	40.20	37.85
-08Y	37.50	45.20	42.85

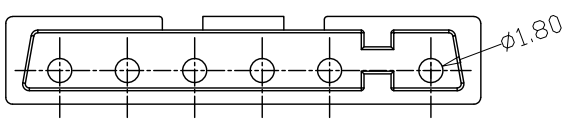
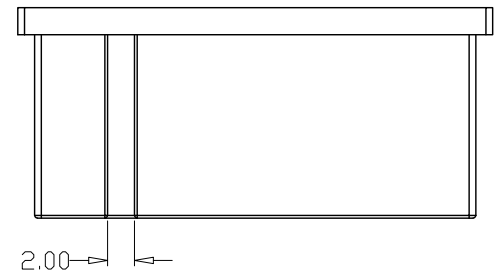
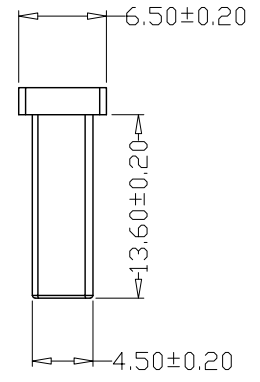
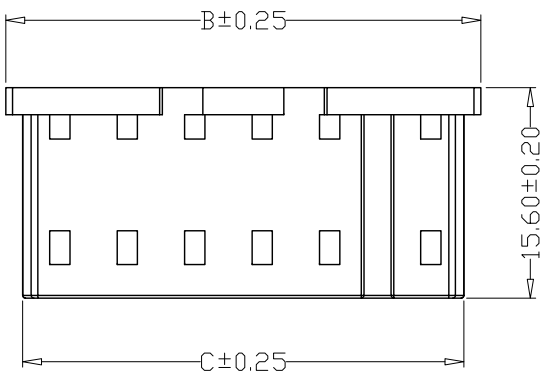
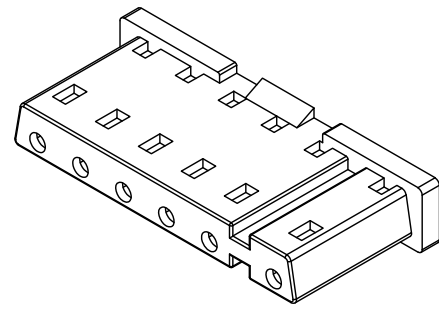
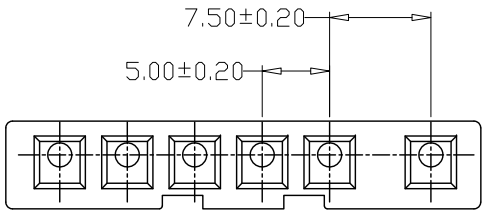

SPECIFICATIONS

- 1、Current Rating: 7A AC, DC
- 2、Voltage Rating: 250V AC, DC
- 3、Temperatuer Range: -25°C~+85°C
- 4、Contact Resistance: 20mΩ Max
- 5、Insulation Resistance: 1000MΩ Min
- 6、Withstanding Voltang: 1500V AC/minute
- 7、Material: PA66, UL94V-0

GENREL TOLERANCE		制图 Mapping	张迎春 2022、09、19	料号 PART NO.	A750-501-02-nY	版本 REV.	A
X±0.25	X°±2°	审核 Audit	钱岳生 2022、09、19	品名 TITLE	CJ84孔座	页次 SHEET	1/1
.X±0.25	.X°±1°	核准 Approved	张名 2022、09、20	客户料号 CUTM. NO.			
.XX±0.15	.XX°±0.5°	单位 Units	mm	比例 SCALE			
.XXX±0.10	.XXX°±0.5°			 乐清市宏一电子有限公司 YueQing HongYi Electronics Co., Ltd			

版本 REV.	日期 DATE	ECN NO.	变更内容 DESCRIPTION	制图 DRAWN

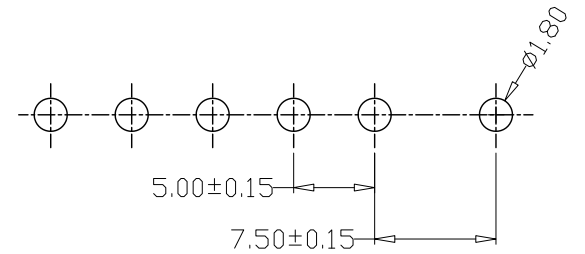
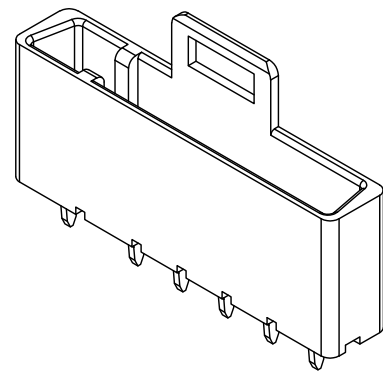
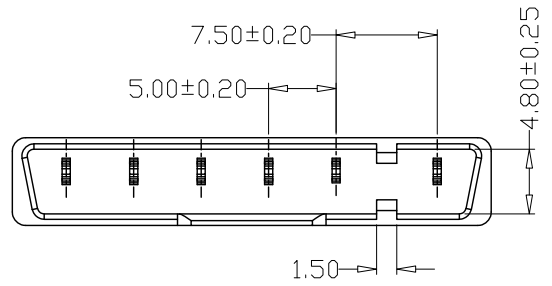

PCB LAYOUT

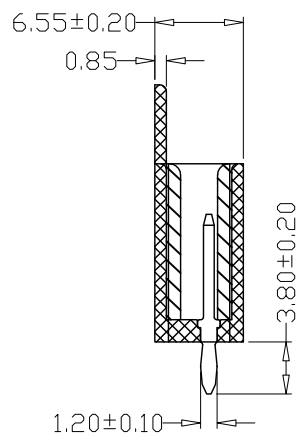
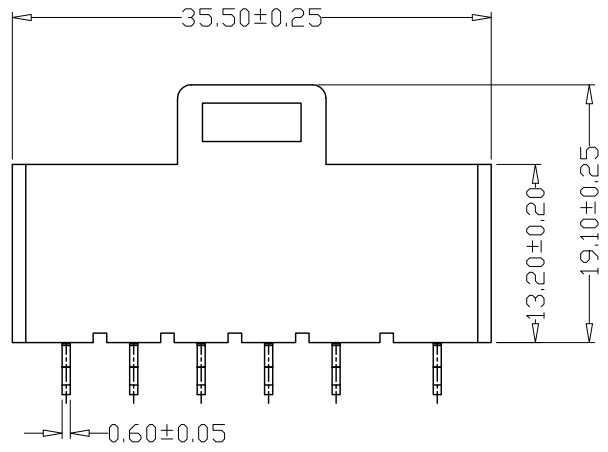

SPECIFICATIONS

- Current Rating: 7A AC, DC
- Voltage Rating: 250V AC, DC
- Temperatuer Range: -25°C~+85°C
- Contact Resistance: 20mΩ Max
- Insulation Resistance: 1000MΩ Min
- Withstanding Voltang: 1500V AC/minute
- Material: Wafer PA66, UL94V-0
PIN Brass Tin-plated

GENEERL TOLERANCE		制图 Mapping	张迎春 2022、12、08		料号 PART NO.	A750-501-02-nA	版本 REV.	A
X±0.25	X°±2°	审核 Audit	钱岳生 2022、12、08		品名 TITLE	CJ84直针 WAFER DIP TYPE	页次 SHEET	1/2
.X±0.25	.X°±1°	核准 Approved	张名 2022、12、09		客户料号 CUTM. NO.			
.XXX±0.10	.XXX°±0.5°	单位 Units	mm	比例 SCALE	 乐清市宏一电子有限公司 YueQing HongYi Electronics Co., Ltd			

版本 REV.	日期 DATE	ECN NO.	变更内容 DESCRIPTION	制图 DRAWN

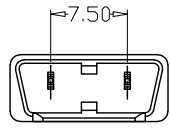

2A

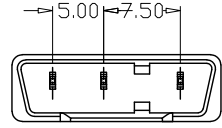

3A

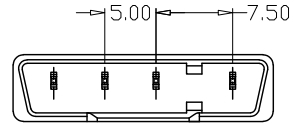

4A

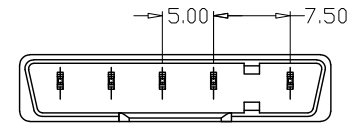

5A

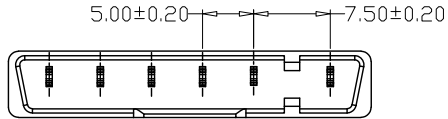
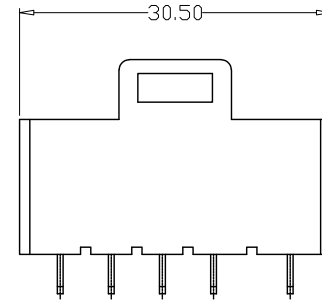
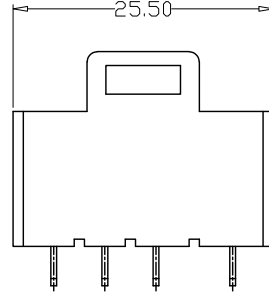
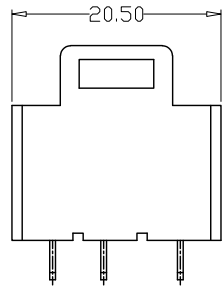
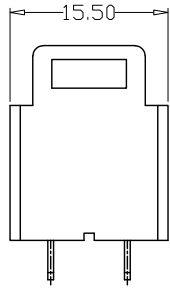

6A

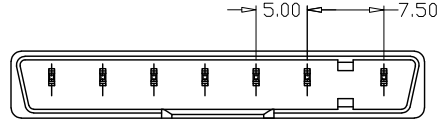

7A

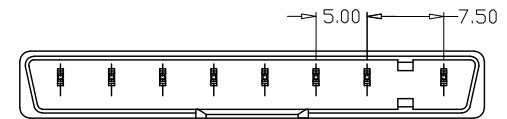

8A

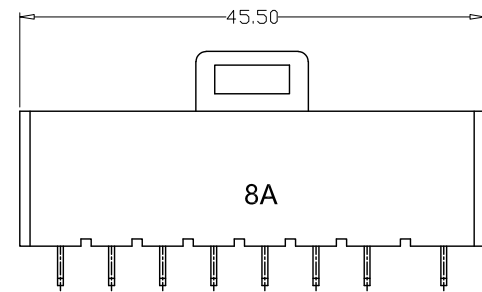
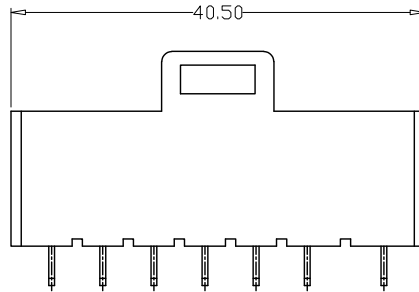
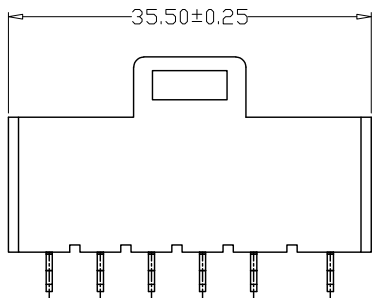

GENERAL TOLERANCE		制图 Mapping	张迎春 2022、12、08		料号 PART NO.	A750-501-02-nA	版本 REV.	A	
X±0.25	X°±2°	审核 Audit	钱岳生 2022、12、08		品名 TITLE	CJ84直针 WAFER DIP TYPE	页次 SHEET	2/2	
.X±0.25	.X°±1°	核准 Approved	张名 2022、12、09		客户料号 CUTM. NO.				
.XX±0.15	.XX°±0.5°	单位 Units	mm	比例 SCALE	乐清市宏一电子有限公司 YueQing HongYi Electronics Co., Ltd				
.XXX±0.10	.XXX°±0.5°								